

Article number: 12317000050400  
Description: KLEE-coil 317 000 050.400  
M5 St. steel 1.4105 slotted pin

## Measures

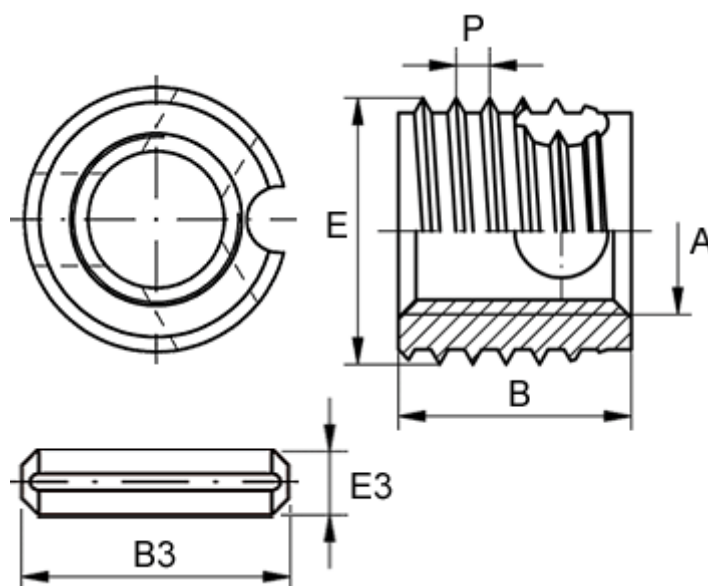

Female thread A	= M5
Length B	= 7
Male thread E	= 8.0
Min hole depth blind hole	= 9
Slotted pin B3	= 4
Slotted pin E3	= 2
Thread pitch P	= 1.00
Type	= 317 000 050 ...